

# Pella® Reserve™

## Traditional Wood & Clad/Wood



Exquisitely designed windows and doors with unparalleled historical detailing.

Double-Hung Interior



Double-Hung Exterior



- Easy-to-learn Pella Steady Set™ interior installation system**  
 Pella Steady Set Interior Installation System is a revolutionary, award-winning and safer way to install new construction windows.<sup>1</sup> The simple system is the fastest, most labor efficient wood window installation system with uncompromising quality.<sup>2</sup> Available on select windows.
- Historical Details**  
 Our most historically authentic line of wood windows and patio doors. Featuring through-stile construction, deliberate proportions and intricate profiles. Pella Reserve – Traditional products are the ideal choice for historical renovations and traditional building projects.
- Authentic hardware**  
 Complement your project with historically authentic spoon-lock window hardware. Our Antiek casement window hardware is inspired by period furniture to deliver authentic traditional style.
- Architectural interest**  
 Pella's Integral Light Technology® grille helps capture the look of true-divided-light without sacrificing energy performance. Further your aesthetic with the putty profile, recreated with historically accurate angles to provide meaningful depth and a realistic shadow. Pella Reserve products offer the industry's deepest sash dimension.
- Virtually unlimited customization**  
 If you can dream it, we can build it with our most customizable product line. From extra tall to extra wide, Pella can craft unique windows that complement your aesthetic. Custom sizes, grille patterns and designs, finishes, wood types and glass options are available.
- Tailor-made solutions**  
 From preliminary drawings to installation, Pella's expert team of architects, engineers, drafters and consultants can work to deliver custom window and door solutions for your project. Partner with Pella to achieve your unique vision without concessions.
- Intentional innovation**  
 The award-winning Integrated Rolscreen® retractable screen preserves aesthetics and the view. It is a double- and single-hung screen that appears when you open the window and rolls away, out of sight, when you close it.
- Durable interiors and extruded aluminum exteriors**  
 To help you save time on the jobsite, interior finish options are available in a variety of colors, or primed and ready-to-paint. To complement your exterior aesthetic, choose from our carefully curated color palette or define your own custom color for your project.
- ENERGY STAR® certified<sup>3</sup>**  
 Pella wood products offer energy-efficient options that will meet or exceed ENERGY STAR guidelines in all 50 states.
- Testing beyond requirements**  
 All wood products and testing are not created equal. Pella raises the bar on industry standard testing and beyond to deliver long-lasting products and reduced callbacks. Every Pella wood window and door passes 5, on average, quality checks before it arrives on the jobsite.
- Best limited lifetime warranty<sup>4</sup>**  
 Pella Reserve products are covered by the best limited lifetime warranty in the business for wood windows and patio doors.<sup>4</sup>

Available in these window and patio door styles:



Special shape windows also available.

<sup>1,2,3,4</sup> See back cover for disclosures.

## Product Specifications

Window & Patio Door Styles	Min. Width	Min. Height	Max. Width	Max. Height	Performance Class & Grade	Performance Values			Frame / Install
						U-Factor	SHGC	STC	
Awning	13-3/4"	13-3/4"	59"	59"	LC30 - CW50	0.25-0.29	0.18-0.47	27-35	Pella Steady Set <sup>®</sup> , Fold-out Fin, Block Frame, EnduraClad Exterior Trim / Brickmould
Casement	13-3/4"	13-3/4"	47"	108"	R35-CW50	0.25-0.29	0.18-0.47	27-34	
Fixed Casement	10"	10"	144"	144"	R35-CW50	0.25-0.29	0.18-0.47	27-35	
Double-Hung	14"	24-3/8"	48"	96"	CW30-CW50	0.25-0.30	0.19-0.53	28-35	
Precision Fit Double-Hung	13-1/2"	23-3/4"	48"	84"	CW40-CW50	0.25-0.31	0.19-0.53	26-30	Pocket Replacement
Monumental Hung	13-3/4"	24"	72"	144"	LC25-CW50	0.25-0.30	0.17-0.47	29-34	Fold-out Fin, Block Frame, EnduraClad Exterior Trim / Brickmould
In-Swing Hinged Patio Door (Single)	18"	36"	48"	119-1/2"	LC40-LC55	0.25-0.29	0.14-0.40	31-35	
In-Swing Hinged Patio Door (Double)	36"	36"	96"	119-1/2"	LC40-LC55	0.25-0.29	0.14-0.40	31-35	
Out-Swing Hinged Patio Door (Single)	18"	36"	48"	119-1/2"	R50-LC70	0.25-0.30	0.14-0.39	30-36	
Out-Swing Hinged Patio Door (Double)	36"	36"	96"	119-1/2"	R50-LC70	0.25-0.30	0.14-0.39	30-36	
Sliding Patio Door (OX, XO)	60"	74"	120"	120"	R20-LC50	0.26-0.31	0.20-0.51	0.28-0.33	
Sliding Patio Door (OXO)	90"	74"	180"	120"	R20-LC35	0.26-0.31	0.20-0.51	—	
Sliding Patio Door (OXXO)	117"	74"	237"	120"	R20-LC35	0.26-0.31	0.20-0.51	—	
Multi-Slide Patio Door	40-1/4"	50-1/2"	701-5/8"	119-1/2"	R15-LC25 <sup>3</sup>	0.30-0.36	0.15-0.46	31	For more info visit PellaADM.com
Bifold Patio Door	31-3/4"	55-1/2"	312"	119-1/2"	R15-LC25 <sup>3</sup>	0.26-0.44	0.13-0.45	—	

Window sizes available in 1/8" increments

Special sizes available. For more information regarding performance, visit [pella.com/performance](http://pella.com/performance). For more information regarding frame and installation types, visit [PellaADM.com](http://PellaADM.com).

## Grilles

### Integral Light Technology<sup>®</sup>

Choose the look of true divided light without sacrificing energy performance.

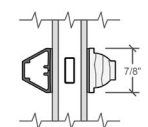

Putty Glaze Exterior with Ogee Interior<sup>4</sup>  
7/8", 1-1/4" or 2"

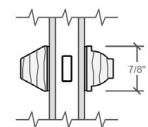

Putty Glaze Exterior with Ogee Interior<sup>4</sup>  
7/8", 1-1/4" or 2"

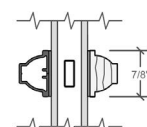

Ogee Exterior with Ogee Interior<sup>4</sup>  
7/8", 1-1/4" or 2"

## Cross Sections

### Cross Sections

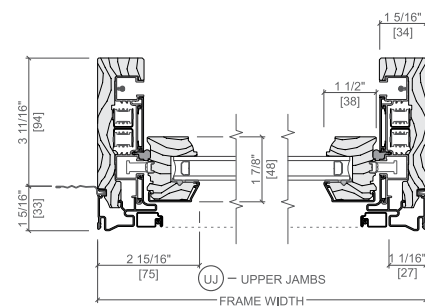

The double-hung cross sections provide visual reference to the historic putty exterior profile and traditional, beveled Ogee interior that add architectural interest to your project.

<sup>3, 4</sup> See back cover for disclosures.

## Window Hardware

### Classic Collection

Get a timeless look with authentic styles in classic finishes.



Fold-away Crank  
Antiek



Spoon-Style Lock

Finishes:

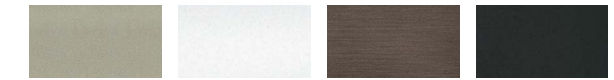

Champagne White Brown Matte Black



Oil-Rubbed Bronze Satin Nickel Satin Brass

### Rustic Collection

Create a distinct and charming look with distressed finishes.



Fold-away Crank  
Antiek



Spoon-Style Lock

Finishes:



Distressed Bronze Distressed Nickel

### Essential Collection

Select from popular designs and finishes to suit every style.



Fold-away Crank



Cam-Action Lock

Finishes:

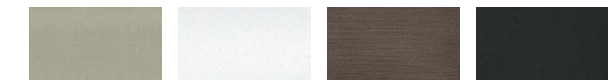

Champagne White Brown Matte Black



Oil-Rubbed Bronze Satin Nickel Satin Brass

## Patio Door Hardware

### Classic Collection

Choose timeless pieces, created in collaboration with Baldwin<sup>®</sup> Hardware, for a look that will never go out of style.

### BALDWIN



Hinged & Bifold Patio Door Handle  
Virago



Sliding & Multi-Slide Patio Door Handle  
Ambrose



Multi-Slide Patio Door Handle<sup>5, 6</sup>

Finishes:

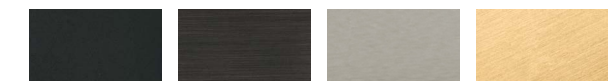

Matte Black Oil-Rubbed Bronze Satin Nickel Satin Brass

### Essential Collection

Elevate your style and transform a home with elegant selections.



Hinged & Bifold Patio Door Handle  
Standard



Sliding Patio Door Handle  
Standard



Multi-Slide Patio Door Handle<sup>5, 6</sup>

Finishes:

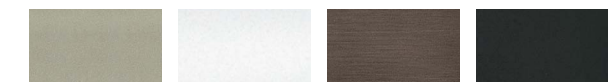

Champagne White Brown Matte Black

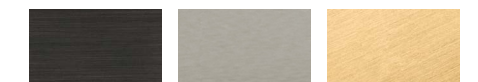

Oil-Rubbed Bronze Satin Nickel Satin Brass

Additional hardware collections available. Visit [PellaADM.com](http://PellaADM.com) for more information.

<sup>5, 6</sup> See back cover for disclosures.

# Colors

## Wood Types

Choose the wood species that best complements your project's interior.

Custom solutions:



Pine



Douglas Fir



Mahogany



White Oak



Red Oak



Cherry



Maple

## Prefinished Pine Interior Colors

Custom interior finishes, unfinished or primed and ready-to-paint are also available.

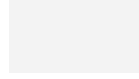

White

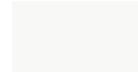

Bright White

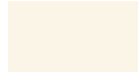

Linen White



Natural



Golden Oak



Early American



Provincial



Dark Mahogany



Charcoal



Black

## Extruded Aluminum-Clad Exterior Colors

Our low-maintenance EnduraClad® exterior finish resists fading. Take durability one step further with EnduraClad Plus which also resists chalking and corrosion.<sup>7</sup>



Black

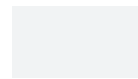

White



Brown



Fossil



Iron Ore



Portobello



Putty



Almond

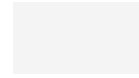

Classic White



Brick Red



Hartford Green



Pearl Gray



Soft Linen



Satin Steel



Matte Gray



Wolf Gray



Spice Red



Sage



Frost Blue



Blue Ash



Custom colors are also available.

## Screens

### Rolscreen®

Rolscreen soft-closing retractable screens roll out of sight when not in use. Available on casement windows.

### Integrated Rolscreen®

A concealed retractable screen that moves seamlessly with the sash of a single- or double-hung window – appearing when you open the window and rolling out of sight when you close it.

### TuffScreen® by Phifer®

The TuffScreen® is 2.5x stronger than a standard screen.<sup>8</sup> It is tear, puncture and damage resistant, standing up to pets, children and harsh weather. Available on sliding patio doors.

\*All trademarks are property of their respective owners

### Flat

InView™ screens are clearer than conventional screens and come standard.



## The Best Limited Lifetime Warranty in the Industry

We know your reputation matters and you stake your reputation on quality, dependable products. That's why we have the best limited lifetime warranty in the industry for wood windows and patio doors.<sup>2</sup>

<sup>1</sup> Some Pella products may not meet ENERGY STAR® guidelines in Canada. For more information, contact your local Pella sales representative or go to [energystar.gc.ca](http://energystar.gc.ca).

<sup>2</sup> Based on comparing written limited warranties of leading national wood window and wood patio door brands. See written limited warranty for details, including exceptions and limitations, at [pella.com/warranty](http://pella.com/warranty) or contact Pella Customer Service.

<sup>3</sup> Ratings are contingent on product configurations.

<sup>4</sup> Color-matched to your product's interior and exterior color. Offering may vary by product type. See Pella sales representative for details.

<sup>5</sup> Flush multi-slide handle is a Pella exclusive design.

<sup>6</sup> Flush multi-slide handle is not available in Champagne.

<sup>7</sup> EnduraClad Plus protective finish is not available with all colors. See your local Pella sales representative for availability.

<sup>8</sup> Based on the composite results of a 5-panel strength analysis comparing TuffScreen and standard screening.



Detailed Product Description - Aluminum-Clad Exterior

**Frame**

- Select softwood, immersion treated with Pella's EnduraGuard® wood protection formula in accordance with WDMA I.S.-4. The EnduraGuard formula includes three active ingredients for protection against the effects of moisture, decay, stains from mold and mildew. Plus, an additional ingredient adds protection against termite damage.
- Interior exposed surfaces are [clear pine] [mahogany] [douglas fir].
- Exterior surfaces are clad with aluminum.
- Components are assembled with screws, staples and concealed corner locks.
- Overall frame depth is 5" (127mm) for a wall depth of 3-11/16" (94mm).
- Optional factory applied jamb extensions available between 3-13/16" (97mm) and 9-3/16" (233mm).
- Vinyl jamb liner with wood / clad inserts.
- Optional factory installed fold-out installation fins with flexible fin corners.
- Optional factory-applied EnduraClad® exterior trim.
- Optional factory-installed Pella Steady Set Installation System.

**Sash**

- Select softwood, immersion treated with Pella's EnduraGuard® wood protection formula in accordance with WDMA I.S.-4. The EnduraGuard formula includes three active ingredients for protection against the effects of moisture, decay, stains from mold and mildew. Plus, an additional ingredient adds protection against termite damage.
- Interior exposed surfaces are [clear pine] [mahogany] [douglas fir]. Any curved member may have visible finger-jointed surfaces.
- Exterior surfaces are clad with extruded aluminum butt-jointed at all corners of the sash with through-stile construction and sealed.
- Corners mortised and tenoned, glued and secured with metal fasteners.
- Sash thickness is 1-7/8" (47mm).
- Double-Hung: Upper sash has surface-mounted wash locks for easy tilt-in cleaning] [Single-Hung: Fixed upper sash has surface-mounted wash locks] [Arch Head units have no wash locks].
- Lower sash has concealed wash locks in lower check rail allowing sash to tilt in for easy cleaning.
- Simulated-Hung units have non-operable upper and lower sashes.
- Sash exterior profile is [ogee] [putty glaze], interior profile is ogee.

**Weatherstripping**

- Water-stop santoprene-wrapped foam at head and sill.
- Thermoplastic elastomer bulb with slip-coating set into lower sash for tight contact at check rail.
- Kerf mounted bristle weatherstrip at sill.
- Vinyl-wrapped foam inserted into jamb liner to seal against sides of sash.

**Glazing System**

- Quality float glass complying with ASTM C 1036.
- Custom and high altitude glazing available.
- Silicone-glazed dual-pane 11/16" dual-seal insulating glass [[annealed] [tempered]], [[clear] [[Advanced] [SunDefense™] [SunDefense+] [NaturalSun] [NaturalSun+] [AdvancedComfort] Low-E [with argon]] [[bronze] [gray] [green] Advanced Low-E [with Argon]]] [obscure] [Reflective Bronze].
- Silicone-glazed dual-pane 13/16" dual-seal [[annealed] [tempered]] non-impact laminated glass [[clear] [[Advanced] [SunDefense] Low-E [with Argon]] [[bronze] [gray] [green] Advanced Low-E [with argon]].

**Exterior**

- Aluminum-clad exteriors shall be finished with EnduraClad® protective finish, in a multi-step, baked-on finish.
  - Color is [standard] [feature] [custom]<sub>1</sub>.
- Aluminum-clad exteriors shall be finished with EnduraClad Plus protective finish with 70% fluoropolymer resin in a multi-step, baked-on finish.
  - Color is [standard] [feature] [custom]<sub>1</sub>.

**Interior**

- [Unfinished, ready for site finishing] [factory primed with one coat acrylic latex] [pine: factory prefinished [paint] [stain]<sub>1</sub>].

**Hardware**

- Galvanized block-and-tackle balances are connected to self-locking balance shoes which are connected to the sashes using zinc die cast terminals and concealed within the frame.
- Sash lock is [standard (cam-action)] [historic spoon-style] [air-conditioner lock] [simulated lock (Single-piece lock ties upper and lower sash together. When removed lower sash becomes operable)]. Two sash locks on units with frame width 37" and greater.
- Optional sash lift furnished for field installation. Two lifts on units with frame width 37" and greater.
- Hardware finish is [baked enamel [Champagne] [White] [Brown] [Matte Black]] [Satin Brass] [Satin Nickel] [Oil-rubbed Bronze] [Distressed Bronze] [Distressed Nickel].

**Optional Products**

**Sash**

- Exterior sash lugs
  - Optional factory applied accessory. Exterior finish is [Standard<sub>1</sub>] [Custom<sub>1</sub>].

**Grilles**

- Integral Light Technology® grilles
  - Interior grilles are [5/8"] [7/8"] [1-1/4"] [2"] ogee profile that are solid [pine] [mahogany] [douglas fir]. Interior surfaces are [unfinished, ready for site finishing] [factory primed] [pine: factory prefinished [paint] [stain] <sub>1</sub>].
  - Exterior grilles are [5/8" putty glaze profile] [7/8" [putty glaze] [ogee] profile] [1-1/4" [putty glaze] [ogee] profile] [2" ogee profile] that are extruded aluminum.
  - Patterns are [Traditional] [Prairie] [Top Row] [New England] [Victorian].
  - Insulating glass contains non-glare spacer between the panes of glass.
  - Grilles are adhered to both sides of the insulating glass with VHB acrylic adhesive tape and aligned with the non-glare spacer.

**Grilles-Between-the-Glass<sub>2</sub>**

- Insulating glass contains 3/4" contoured aluminum grilles permanently installed between two panes of glass.
- Patterns are [Traditional] [9-Lite Prairie] [Cross] [Top Row]
- Interior color is [White] [Tan<sub>3</sub>] [Brown<sub>3</sub>] [Putty<sub>3</sub>] [Black] [Ivory] [Harvest] [Cordovan] [Brickstone].
- Exterior color<sub>4</sub> is [standard]<sub>1</sub>.

**Screens**

- Integrated Rolscreen® (for rectangular units only)<sub>6</sub>
  - Retractable screen integrated into [lower sash] [both upper and lower sash]. Screen rollers are fixed and concealed within the frame, screen is held to the sash by magnets which release when the bottom sash is tilted for cleaning, and when the upper sash is opened past 18".
  - InView Screen cloth, black vinyl-coated 18/18 mesh fiberglass screen cloth complying with ASTM D 3656 and the performance requirements of SMA 1201.
- InView™ screens
  - [Half-Size] [Full-Size<sub>4</sub>] black vinyl-coated 18/18 mesh fiberglass screen cloth complying with the performance requirements of SMA 1201, set in a [standard roll-form] [premium extruded] aluminum frame fitted to outside of window, supplied complete with all necessary hardware.
  - Full screen spreader bar placed on units > 37" width or > 65" height.
  - Screen frame finish is [standard screen: baked enamel] [premium extruded: baked enamel], color to match window cladding.

**Hardware**

- Optional factory applied limited opening device available for vent units in stainless steel; nominal 3-3/4" opening. Limiting device concealed from view.
- Optional factory applied window opening control device. Device allows window to open less than 4" with normal operation, with a release mechanism that allows the sash to open completely. Complies with ASTM F2090-10.

(1) Contact your local Pella sales representative for current designs and color options.

(2) Available in clear or Low-E insulating glass only.

(3) Tan, Brown and Putty Interior GBG colors are available in single-tone (Brown/Brown, Tan/Tan or Putty/Putty). Other interior colors are also available with Tan or Brown exterior.

(4) Appearance of exterior grille color will vary depending on Low-E coating on glass.

(5) Full screens are available on units ≤ 96" height.

(6) Integrated Rolscreen only available on sizes ≥ 34" tall and 21" wide, and ≤ 84" tall and 48" wide.



## Detailed Product Description - Wood Exterior

### Frame

- Select softwood, immersion treated with Pella's EnduraGuard® wood protection formula in accordance with WDMA I.S.-4. The EnduraGuard formula includes three active ingredients for protection against the effects of moisture, decay, stains from mold and mildew. Plus, an additional ingredient adds protection against termite damage.
- Interior exposed surfaces are [clear pine] [mahogany] (standard rectangular windows only). Any curved member may have visible finger-jointed surfaces.
- Exterior surfaces are [pine] [mahogany].
- Overall frame depth is 4-3/8" (111mm) for a wall depth of 4-3/16" (106mm).
- Vinyl Jamb liner includes wood / clad inserts.
- Optional factory applied jamb extensions available between 4-5/16" (110mm) and 9-3/16" (233mm).

### Sash

- Select softwood, immersion treated with Pella's EnduraGuard® wood protection formula in accordance with WDMA I.S.-4. The EnduraGuard formula includes three active ingredients for protection against the effects of moisture, decay, stains from mold and mildew. Plus, an additional ingredient adds protection against termite damage.
- Interior exposed surfaces are [clear pine] [mahogany] (standard rectangular windows only). Any curved member may have visible finger-jointed surfaces.
- Exterior surfaces are [pine] [mahogany].
- Sash exterior profile is putty glaze, interior profile is ogee.
- Corners [mortised and tenoned on rectangular units] [mitered on arch head units], glued and secured with metal fasteners.
- Sash thickness is 1-7/8" (47mm).
- [Double-Hung: Upper sash has surface-mounted wash locks] [Single-Hung: Fixed upper sash has surface-mounted wash locks] [Arch Head units have no wash locks].
- Lower sash has concealed wash locks in lower check rail.
- Sashes tilt in for easy cleaning.
- Simulated-Hung units have non-operable upper and lower sashes.

### Weatherstripping

- Water-stop santoprene-wrapped foam at head and sill. Thermoplastic elastomer bulb with slip-coating set into lower sash for tight contact at check rail.
- Kerf mounted bristle weatherstrip at sill.
- Vinyl-wrapped foam inserted into jamb liner to seal against sides of sash.

### Glazing System

- Quality float glass complying with ASTM C 1036.
- Custom and high altitude glazing available.
- Silicone-glazed 11/16" dual-seal insulating glass [[annealed] [tempered]] [[clear] [[Advanced] [SunDefense™] [SunDefense+] [AdvancedComfort] [NaturalSun] [NaturalSun+] Low-E [with argon]] [bronze] [gray] [green] Advanced Low-E with argon].

### Exterior

- [Pine: factory primed with one coat acrylic latex] [Mahogany: [factory primed with one coat acrylic latex] [Unfinished, ready for site finishing]].

### Interior

- [Unfinished, ready for site finishing] [factory primed with one coat acrylic latex] [pine: factory prefinished [paint] [stain]<sub>1</sub>].

### Hardware

- Galvanized block-and-tackle balances are connected to self-locking balance shoes which are connected to the sashes using zinc die cast terminals and concealed within the frame.
- Sash lock is [standard (cam-action)] [historic spoon-style] [air-conditioner lock] [simulated lock (Single-piece lock ties upper and lower sash together. When removed lower sash becomes operable)]. Two sash locks on units with frame width 37" and greater.
- Optional sash lift furnished for field installation. Two lifts on units with frame width 37" and greater.
- Hardware finish is [baked enamel [Champagne] [White] [Brown] [Matte Black]] [satin brass] [satin nickel] [oil-rubbed bronze] [distressed bronze] [distressed nickel].

### Optional Products

#### Grilles

- Integral Light Technology® grilles
  - Interior grilles are solid [5/8"] [7/8"] [1-1/4"] ogee profile that are solid [pine] [mahogany]. Interior surfaces are [unfinished, ready for site finishing] [factory primed] [pine: factory prefinished [paint] [stain]<sub>1</sub>].
  - Exterior grilles are solid [5/8"] [7/8"] [1-1/4"] putty glaze profile that are [pine] [mahogany]. Exterior surfaces are water repellent, preservative-treated in accordance with WDMA I.S.-4, and are [unfinished, ready for site finishing] [factory primed].
  - Patterns are [Traditional] [Prairie] [Top Row] [New England] [Victorian].
  - Insulating glass contains non-glare spacer between the panes of glass.
  - Grilles are adhered to both sides of the insulating glass with VHB acrylic adhesive tape and aligned with the non-glare spacer
- or –
- Grilles-Between-the-Glass<sub>2</sub>
  - Insulating glass contains 3/4" contoured aluminum grilles permanently installed between two panes of glass.
  - Patterns are [Traditional] [9-Lite Prairie] [Cross] [Top Row]
  - Interior color is [White] [Tan<sub>3</sub>] [Brown<sub>3</sub>] [Putty<sub>3</sub>] [Black] [Ivory] [Harvest] [Cordovan] [Brickstone].
  - Exterior color<sub>5</sub> is [standard]<sub>1</sub>.

#### Screens

- InView™ Screens
  - [Half-Size] [Full-Size<sub>4</sub>] black vinyl-coated 18/18 mesh fiberglass screen cloth complying with the performance requirements of SMA 1201, set in a [standard roll-form aluminum frame with 3/4" wide rails and stiles] [premium extruded aluminum frame with 1" wide rails and stiles] fitted to outside of window, supplied complete with all necessary hardware.
  - Full screen spreader bar placed on units > 37" width or > 65" height.
  - Insect screen frame finish is baked enamel.

#### Hardware

- Optional factory applied limited opening device available for vent units in stainless steel; nominal 3-3/4" opening. Limiting device concealed from view.
- Optional factory applied window opening control device. Device allows window to open less than 4" with normal operation, with a release mechanism that allows the sash to open completely. Complies with ASTM F2090-10.

(1) Contact your local Pella sales representative for current designs and color options.

(2) Available in clear or Low-E insulating glass with argon, and obscure insulated glass.

(3) Tan, Brown and Putty Interior GBG colors are available in single-tone (Brown/Brown, Tan/Tan or Putty/Putty). Other interior colors are also available with Tan or Brown exterior.

(4) Full screens are available on units ≤ 96" height.

(5) Appearance of exterior grille color will vary depending on Low-E coating on glass.